

Kea Script

Childrens Fixed Frame Day Wheelchair 90700



To Order Fill in the frame dimensions and features required. For variations describe in detail on a separate page. If you have any further questions contact us at the address at the bottom of the page.

SEND FORM
If online, click here to send via e-mail

Date _____

Name _____

Address _____

Phone _____

Fax / Cell _____

Email _____

Disability _____

Weight _____

Height _____

Delivery details _____

Therapist details _____

Required by _____

TRIAL CHAIR REF: _____

Shoe Size _____

T-Shirt Size _____

MEASUREMENTS (Refer to diagram below)

Growable Sizes Sizes up to 12" wide are growable up to 15" wide maximum

A Seat width 8" 10" 12" 2" growable 3" growable 3" growable

B Seat depth (from 8" to a maximum of 16") _____

C Back height _____

D Back angle (from 0° to a maximum of 10°) _____

E Seat to footplate _____

F Seat to floor - front _____

G Seat to floor - rear _____

H Balance Point _____

I Footplate width _____

J Camber (0° or 3°) _____

Back Style
 Folding Back Fixed Back

K Front Style
 Flared Front

IMPORTANT Ensure measurements C, E, F, G provide allowance for the cushion thickness

ADDITIONAL NOTES

(you can type here)

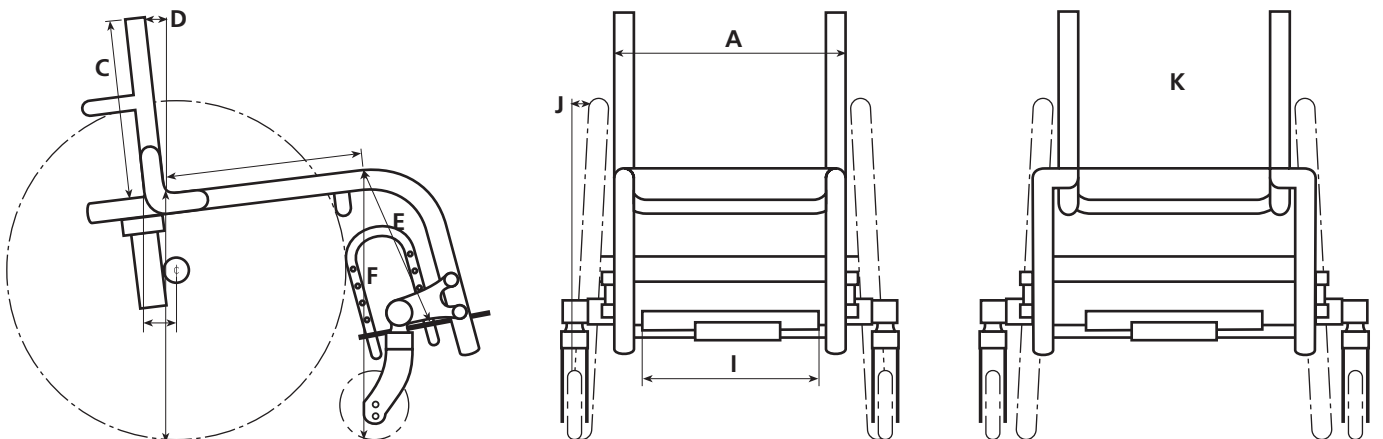

Name _____

FOOTPLATE

- One piece flip back (std)
 Fixed D (std)
 ABS on fixed footplate **AD11500**
 Fixed angle adjustable **AD11520**
 Fabric padded cover on fixed or angle adjustable footplate **AD11510**

CASTORS

- Rollerblade (std)
 4" solid (std)
 5" solid (std)
 5" x 1.5" alloy **AD11740**
 4" x 1.25" alloy **AD11710**
 5" solid alloy **AD11740**
 5" wide soft roll **AD11810**
 4" wide soft roll **AD11806**
 5" x 1.5" solid **AD11720**

FORKS

- Standard adjustable forks (std)

PUSH HANDLES

- Nil
 In back canes **AD14140**
 Single stroller (umbrella shaped handle mounted on grab bar) **AD14208**
 Removable single **AD14150**
 Height from floor to top of handle

BRAKES

- Nil
 Push to lock (std)
 Ergo Scissor **AD14522**
 Brake extension left **AD14550**
 Pull to lock **AD14510**
 Ergo Scissor w/spring **AD14524**
 Brake extension right **AD14550**
 Superlock Push to Lock with Brake Extensions **AD14560**
 Scissor Lock Composite **AD14570**
 Hill climbers **AD14530**

ANTI-TIPS

- Nil
 Pair of single anti-tips with plastic wheels **AD15000**
 Pair of single anti-tips with rollerblades **AD15030**
 Pair of flared single anti-tips with plastic wheels **AD15020**

ARMRESTS

- Nil
 T height adj child's (8") pad armrest with ABS skirt guard **AD15279**
 T height adjustable with child's (8") pad armrest **AD15259**
 T height adj desk (10") pad armrest with ABS skirt guard **AD15280**
 T height adjustable with desk (10") pad armrest **AD15260**

SKIRT GUARDS

- Nil
 ABS drop in **AD16110**
 Fabric skirt guards **AD16100**
 ABS fabric covered **AD16120**
 Mud guards **AD16164**

UPHOLSTERY

- Sling (std)
 No Cushion
 Cushion 2" **AD16202**
 Bag on back of chair **AD16680**
 Tension adjustable back (std)
 Cushion 1" **AD16201**
 Spare Cushion cover **AD16250**
 Impact guards (std)

- Leg strap (std)
 Seat belt with plastic buckle **AD16500**
 Hip strap, 4 point **AD16540**
 Seat belt (child's) with metal car type buckle **AD16520**

TRAY

- Tray slides over armrests **AD17000**
 Tray with prong receivers **AD17010**

Name _____

WHEELS**TYRES****12.5"** 12.5" Transit Wheels**12.5"** 12.5" Tread (std) 12.5" Solid Tread (std)**16"** 16" x 1.75" Composite Wheels**16"** 16" x 1.75" Tread (std) 16" x 1.75" Solid Tread (std)**18"** 18" x 1" Spoked Wheels 18" x 1.75" Composite Wheels**18"** 18" x 1" HP Smooth (std) 18" x 1.75" Grey Tread (std)**20"** 20" Spoked Wheels 20" x 1.75" Spoked Wheels 20" x 1 3/8" Composite Wheels 20" X-Core Composite Wheels**20"** 20" x 1" HP Smooth (std) 20" x 1 3/8" Tread (std) 20" x 1 3/8" Solid Tread (std) 20" x 1.75" Grey Tread (std)**22"** 22" Spoked Wheels 22" X-Core Composite Wheels 22" Spinergy LX Wheels (12 spoke - black only) **AD13310****22"** 22" x 1" HP Smooth (std) 22" x 1 3/8" Tread (std) 22" x 1 3/8" Solid Tread (std) Spare Wheel(s) Type: _____

Tyres: _____ Pushrims: _____ Size: _____

AXLES Quick release axles (std) Quad release **AD12500****PUSHRIMS** Anodised (std) Rubber Coated (black) **AD13850** Capstan **AD13880**

No. projections: _____

Angle: _____



















Length: _____

PUSHRIMS - POSITION Standard In close Onto rim**SPOKE GUARDS** Nil Clear polycarb **AD13900** Black ABS **AD13901** Custom design **AD13910**
Describe design below**ADDITIONAL NOTES**

(you can type here)

Name _____

COLOURS

- 27 Candy Blue 
- 1 Royal Blue 
- 72 Glass Blue 
- 16 Candy Purple 
- 48 Burgundy 
- 83 Candy Raspberry 
- 88 Fluro Pink 
- 28 Candy Red 
- 11 Flame 
- 57 Super Hot Chilli 
- 80 Candy Orange 
- 71 Pure Orange 
- 68 Crystal Yellow 
- 73 Crystal Jade 
- 89 Fluro Green 
- 70 Candy Emerald 
- 2 Hawthorn Green 
- 17 Crystal Sapphire 

ATTENTION









THIS IS A GUIDE TO COLOURS ONLY, how colours appear on your monitor or when printed out may vary.

Contact us if you require assistance or a colour sample.

This colour selection is for our aluminum frames only.

We do not recommend powder coating titanium.

Colour availability is subject to change without notice, contact us if you are concerned about the availability of your colour.

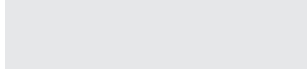
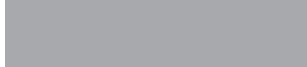
- 55 Silver Sparkle 
- 12 Silver Orbiter 
- 46 Chrome 
- 42 Metallic Viper 
- 30 Satin Black 
- 61 High Gloss Black 
- 62 Matt Black 
- 63 Texture Matt Black 
- 18 Clear 
- Bead Blast** (titanium only) 

Custom Colour (additional cost)

Description