

Orion Script Form

Basketball Sports Wheelchair

90850 - 90850T



To Order Fill in the frame dimensions and features required. For variations describe in detail on a separate page. If you have any further questions contact us at the address at the bottom of the page.

SEND FORM
If online, click here to send via e-mail

Date _____ Delivery details _____

Name _____

Address _____

Phone _____

Fax / Cell _____

Email _____

Required by _____
(Delivery is normally 4-6 weeks from order confirmation)

Disability _____ Grading _____ Weight _____ Height _____ Shoe Size _____ T-Shirt Size _____

MEASUREMENTS (Refer to diagrams)

Frame Materials

Aluminium (std) Titanium **90850T**

Seat Width - Rear _____	F Back Angle° _____	M Pivot Centres _____	S <input type="checkbox"/> Flexible Backpost Cap AD20310 (fixed back height only)
Seat Width - Front _____	G Seat to Footplate _____	N Footplate Position _____	WING BAR
A Back Width _____	H Frame Length (centre of camber bar to front of wing bar) _____	O Between Wheels _____	T <input type="checkbox"/> U <input type="checkbox"/>
B Seat Length _____	I Wheel Base (centre of camber bar to centre of pivot) _____	P Camber _____	ERGO SEAT AD10220 (A) AD10221 (T)
C Back Splay - Top _____	J Seat to Floor - Front _____	Q Footplate Width _____	V Ergo Seat - Length _____
D Back Splay - Length _____	K Seat to Floor - Rear _____	R BINDING MOUNTS	W Ergo Back - Height _____
E Back Height _____	L Balance Point _____	<input type="checkbox"/> Std <input type="checkbox"/> Custom AD20315 (A) AD20318 (T)	X Ergo Back - Angle _____

ADDITIONAL NOTES

(you can type here)

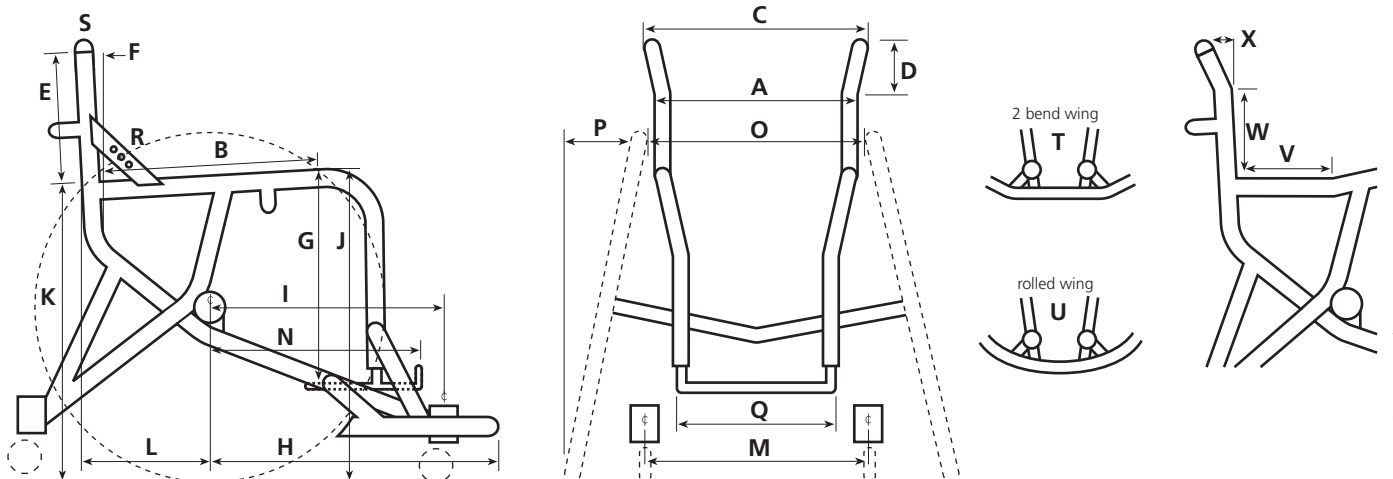

Orion Script Form

Basketball Sports Wheelchair

Name _____

FOOTPLATE

- No Footplate Alloy tube footplate (std) Alloy footplate cover **AD11690**

ANTI-TIPS

- Twin swivel **AD15150 (A)**
AD15151 (T) Single swivel **AD15100 (A)**
AD15102 (T)

BEARINGS

- Standard bearings Melrose hybrid ceramic bearings **AD20400**

CASTORS

- Rollerblade 72mm (std) Other _____

UPHOLSTERY

- Seat sling fixed (std) Fixed width back (std) No cushion Cushion 3" **AD16203**
 Seat sling wrap-around Adjustable back upholstery with Cushion 1" **AD16201** Cushion 1" (high density) **AD16221**
 Solid seat **AD18030** adjustable width/height **AD16050** Cushion 2" **AD16202** Cushion 2" (high density) **AD16220**

SKIRT GUARDS

- No skirt guards Fabric skirt guards **AD16100** Alloy skirt guards **AD16125 (A)**
AD16130 (T) (height) _____
(welded to alloy frame, bolted to titanium frame)
 ABS rigid skirt guards **AD16111** (height) _____

STRAPS, IMPACT GUARDS

- Front hanger covers **AD16400** Hip strap - webbing **AD16510** Leg strap **AD16330**
 Back bar cover **AD16420** Hip strap - ratchet **AD16550** Chest strap **AD45210**
(measure around your chest and seat back)
 Foot strap - webbing (std) Foot strap - ratchet **AD16350**
 Knee strap - ratchet **AD16351**

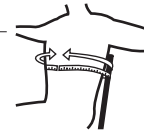
**ACCESSORIES**

- Wheel bag (black with choice of trim colour) **AD16780** (Choose your trim colour) **Bk R Bl Y Gr Pk Pu** Custom Wheel Bag **AD16781**
(describe below)

ADDITIONAL NOTES

(you can type here)

Name _____

WHEELS**24"**

- Spoked Wheels (std)
- Spinergy SL Wheels (24 spoke, black spokes only) **AD13410**
- Spinergy SLX Wheels (24 spoke, black spokes only) **AD13420**

25"

- Spoked Wheels **AD13060**
- Spinergy SL Wheels (24 spoke, black spokes only) **AD13410**
- Spinergy SLX Wheels (24 spoke, black spokes only) **AD13420**

26"

- Spoked Wheels **AD13060**
- Spinergy SL Wheels (24 spoke, black spokes only) **AD13410**
- Spinergy SLX Wheels (24 spoke, black spokes only) **AD13420**

27"

- Spoked Wheels **AD13060**
- Spinergy SL Wheels (24 spoke, black spokes only) **AD13410**
- Spinergy SLX Wheels (24 spoke, black spokes only) **AD13420**

TYRES**24"**

- Kenda Ironcap Blue (std)
- Kenda Konstrictor (std)
- Schwalbe Right Run **AD13740**
- Tufo Tubeless **AD13760**

25"

- Kenda Ironcap Blue (std)
- Kenda Konstrictor (std)
- Kenda Kaliente **AD13721**
- Schwalbe Right Run **AD13740**
- Tufo Tubeless **AD13760**

26"

- Kenda Ironcap Blue (std)
- Schwalbe Right Run **AD13740**
- Tufo Tubeless **AD13760**

27"

- 27" x 1" Kenda Ironcap Blue (std)
- Tufo Tubeless **AD13760**

PUSHRIMS

- Anodised alloy (std) Rubber coated (red) **AD13845**

PUSHRIMS - POSITION

- Standard In close Onto rim

SPOKE GUARDS

- Nil Pair of Spoke guards **AD13920**

SPARE WHEELS as above

- Spoked Wheel 24" **AD13507** (quantity) _____
- Spoked Wheel 25"/26"/27" **AD13561** (quantity) _____
- Spinergy SL Wheel **AD13641** (quantity) _____
- Spinergy SLX Wheel 1/2" axle **AD13651** (quantity) _____

TYRES, TUBES and AXLES on SPARE WHEELS

- Tube fitted **AD13695** (quantity) _____
- Kenda Tyre fitted **AD13701** (quantity) _____
- Schwalbe Tyre fitted **AD13741** (quantity) _____
- Tufo Tyre fitted **AD13760** (quantity) _____
- Axle 1/2" **AD12508** (quantity) _____

SPOKE GUARDS for SPARE WHEELS as above

- Fitted to spare wheel Not fitted to spare wheel
- Spoke Guard **AD13921** (quantity) _____

PUSHRIMS for SPARE WHEELS as above

- Anodised alloy (std) _____
- Rubber coated (red) **AD13846** _____

EXTRA AXLES



















- Axles 1/2" **AD12514** (quantity) _____

EXTRA BEARINGS

- Steel 608 5/16" **AD20402** (quantity) _____
- Steel R8 1/2" **AD20405** (quantity) _____
- Ceramic 608 5/16" **AD20403** (quantity) _____
- Ceramic R8 1/2" **AD20407** (quantity) _____

Name _____

COLOURS

- 27 Candy Blue 
- 1 Royal Blue 
- 72 Glass Blue 
- 16 Candy Purple 
- 48 Burgundy 
- 83 Candy Raspberry 
- 88 Fluro Pink 
- 28 Candy Red 
- 11 Flame 
- 57 Super Hot Chilli 
- 80 Candy Orange 
- 71 Pure Orange 
- 68 Crystal Yellow 
- 73 Crystal Jade 
- 89 Fluro Green 
- 70 Candy Emerald 
- 2 Hawthorn Green 
- 17 Crystal Sapphire 

ATTENTION









THIS IS A GUIDE TO COLOURS ONLY, how colours appear on your monitor or when printed out may vary.

Contact us if you require assistance or a colour sample.

This colour selection is for our aluminum frames only.

We do not recommend powder coating titanium.

Colour availability is subject to change without notice, contact us if you are concerned about the availability of your colour.

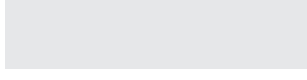
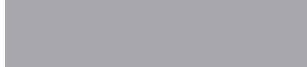
- 55 Silver Sparkle 
- 12 Silver Orbiter 
- 46 Chrome 
- 42 Metallic Viper 
- 30 Satin Black 
- 61 High Gloss Black 
- 62 Matt Black 
- 63 Texture Matt Black 
- 18 Clear 
- Bead Blast** (titanium only) 

Custom Colour (additional cost)

Description