

# Panther Script Form

## Fixed Frame Day Wheelchair 90200

**To Order** Fill in the frame dimensions and features required. For variations describe in detail on a separate page. If you have any further questions contact us at the address at the bottom of the page.

**SEND FORM**  
If online, click here to send via e-mail

Date \_\_\_\_\_

Delivery details \_\_\_\_\_

Name \_\_\_\_\_

Address \_\_\_\_\_

Therapist details \_\_\_\_\_

Phone \_\_\_\_\_

Fax / Cell \_\_\_\_\_

Required by \_\_\_\_\_

Email \_\_\_\_\_

**TRIAL CHAIR REF:** \_\_\_\_\_

Disability \_\_\_\_\_ Weight \_\_\_\_\_ Height \_\_\_\_\_ Shoe Size \_\_\_\_\_ T-Shirt Size \_\_\_\_\_

**MEASUREMENTS** (Refer to diagram below)

**Frame Materials**

Aluminium (std)  Titanium **90200T**

**A** Seat Width \_\_\_\_\_

**F** Frame Length \_\_\_\_\_

**K** Castor Pivot Centres \_\_\_\_\_

Ergo Seat Option **AD10220**

**B** Seat Length \_\_\_\_\_

**G** Seat to Floor - Front \_\_\_\_\_

**L** Footplate Width \_\_\_\_\_

**N** Ergo Seat Length \_\_\_\_\_

**C** Back Height \_\_\_\_\_

**H** Seat to Floor - Rear \_\_\_\_\_

**M** Camber (0° - 5°) \_\_\_\_\_

**O** Ergo Back Height \_\_\_\_\_

**D** Back Angle° \_\_\_\_\_

**I** Balance Point \_\_\_\_\_

**Front Hanger Taper Style**

**P** Ergo Back Angle° \_\_\_\_\_

**E** Seat to Footplate \_\_\_\_\_

**J** Castor Pivot Position \_\_\_\_\_

V Front  Pro T Front

**ADDITIONAL NOTES**

(you can type here)

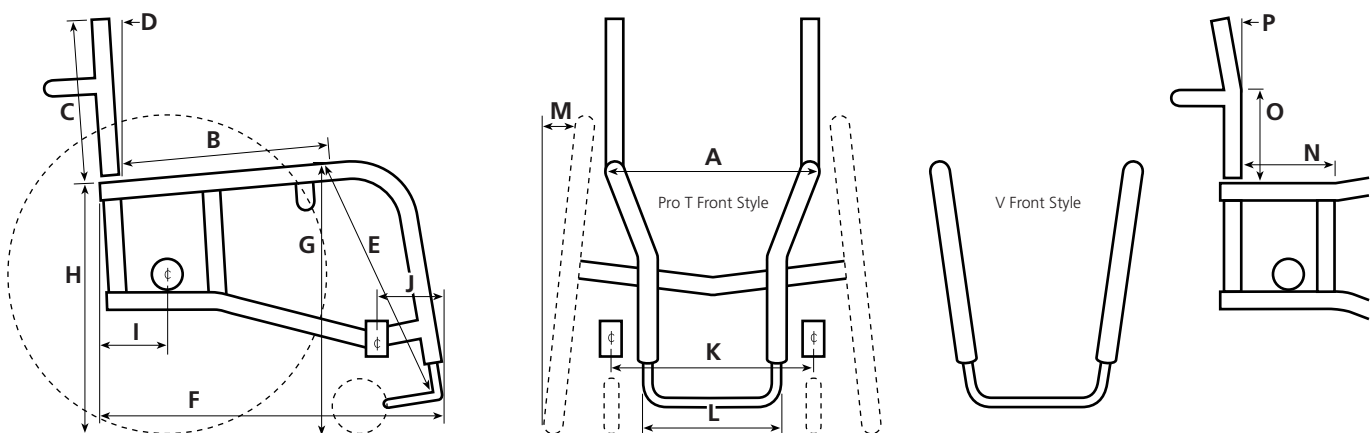

# Panther Script Form

## Fixed Frame Day Wheelchair

Name \_\_\_\_\_

**BACK REST**

- Folding back (std)       Fixed back

**FOOTPLATE**

- Standard       Angle adjustable **AD11520**       ABS on footplate **AD11500**       Fabric padded cover **AD11510**

**CASTORS**

- Rollerblade (std)       5" solid (std)       6" solid (std)       8" solid **AD11760**  
 4" solid (std)       5" solid alloy **AD11740**       6" solid alloy **AD11742**       8" pneumatic **AD11780**  
 4" x 1.25" alloy **AD11710**       5" x 1.5" solid **AD11720**       6" x 1.5" solid **AD11730**  
 4" wide soft roll **AD11806**       5" x 1.5" alloy **AD11740**       6" x 1.5" alloy **AD11742**  
 5" wide soft roll **AD11810**       6" wide soft roll **AD11820**  
 6" pneumatic **AD11750**

**FORKS**

- Standard forks (std)       Ultralight bearing forks **AD11910**       Frog Legs suspension **AD11950**       Frog Legs Unitine **AD11920**

**PUSH HANDLES**

- Nil       Removable **AD14100**       Height adj dual clamp **AD14120**       Foldable in back canes **AD14160**

**BRAKES**

- Nil       Superlock Push to Lock with Brake Extensions **AD14560**       Scissor (std)       Scissor Lock Composite **AD14570**  
 Push to lock (std)       Brake extension left **AD14550**       Ergo Scissor **AD14522**       D's-Locks **AD14600**  
 Pull to lock **AD14510**       Brake extension right **AD14550**       Ergo Scissor w/spring **AD14524**       Hill climbers **AD14530**

**ANTI-TIPS**

- Nil       Single centre mount anti-tip with plastic wheels **AD15070**  
 Pair of single anti-tips with plastic wheels **AD15000**       Single centre mount anti-tip with rollerblades **AD15080**  
 Pair of single anti-tips with rollerblades **AD15030**       Dual tube one piece swivel anti-tip with rollerblade **AD15150**

**ARMRESTS**

- Nil       T adjustable height with desk pad armrest **AD15260**  
 ABS skirt guard attached to full length pad armrest **AD15281**       T adjustable height with full length pad armrest **AD15261**

**UPHOLSTERY**

- Sling (std)       Standard back (std)       No cushion       Bag under chair **AD16600**  
 Tension adjustable back **AD16010**       Cushion 1" **AD16201**       Bag on back of chair **AD16680**  
 Cushion 2" **AD16202**       Bag on right front hanger **AD16620**  
 Cushion 3" **AD16203**       Bag on front left hanger **AD16620**  
 Wheel bag **AD16780**

**SKIRT GUARDS**

- Nil       ABS drop in **AD16110**       Alloy fixed **AD16130**       Carbon Fibre fixed **AD16161**  
 Fabric skirt guards **AD16100**       ABS fabric covered **AD16120**       Alloy folding **AD16140**       Carbon Fibre folding **AD16160**

**STRAPS, IMPACT GUARDS**

- Leg strap (std)       Impact guards front hangers **AD16400**       Impact guards grab bar **AD16420**       Impact guards bottom bar **AD16422**
- Impact guards made only if suitable after fitting anti tips, push handles etc.

# Panther Script Form

## Fixed Frame Day Wheelchair

Name \_\_\_\_\_

**WHEELS****24"**

- Spoked Wheels (std)
- Spinergy Day Wheels (18 spoke) **AD13300** (Choose your spoke colour) **Bk R Bl W Y**
- Spinergy LX Wheels (12 spoke) **AD13310** (Choose your spoke colour) **Bk R Bl W Y Gr Pk O**
- Spinergy LX Wheels with FlexRim (12 spoke - black only) **AD13315**
- X Core Wheels (5 spoke) **AD13108**
- Spider Wheels **AD13100**
- Topolino Wheels **AD13350**
- Dino Wheels **AD13360** (Choose your spoke colour) **Bk R Bl Sv Go Gr Pk O LB Pu**
- Glance Wheels **AD13400** (Wheel Type)
- BMX Wheels (std)

**25"**

- Spoked Wheels (std)
- Spinergy Day (18 spoke) **AD13300** (Choose your spoke colour) **Bk R Bl W Y**
- Spinergy LX (12 spoke) **AD13310** (Choose your spoke colour) **Bk R Bl W Y Gr Pk O**
- Spinergy LX Wheels with FlexRim (12 spoke - black only) **AD13315**
- X Core Wheels (3 spoke) **AD13200**
- Topolino Wheels **AD13350**
- Dino Wheels **AD13360** (Choose your spoke colour) **Bk R Bl Sv Go Gr Pk O LB Pu**
- Glance Wheels **AD13400** (Wheel Type)
- BMX Wheels (std)

**26"**

- Spoked Wheels (std)
- Spinergy Day (18 spoke) **AD13300** (Choose your spoke colour) **Bk R Bl W Y**
- Spinergy LX (12 spoke) **AD13310**
- BMX Wheels (std)

 Spare Wheel(s) Type: \_\_\_\_\_

Tyres: \_\_\_\_\_

Pushrims: \_\_\_\_\_

Size: \_\_\_\_\_

**TYRES****24"**

- 24" x 1" HP Smooth (std)
- 24" x 1" HP Tread (std)
- 24" x 1" Solid (std)
- 24" x 1-3/8" Tread (std)
- 24" x 1-3/8" Solid (std)
- 24" x 1-3/8" Kenda HP Tread **AD13710**
- 24" x 1-3/8" Knobbly V-Trak **AD13715**
- 24" x 1" Kenda Ironcap Blue **AD13700**
- 24" x 1" Kenda Konstrictor **AD13720**
- 24" x 1" Schwalbe Right Run **AD13740**
- 24" x 1" Schwalbe Marathon Evo **AD13750**
- BMX Tread (std)

**25"**

- 25" x 1" HP Smooth (std)
- 25" x 1" Solid (std)
- 25" x 1" Kenda Ironcap Blue **AD13700**
- 25" x 1" Kenda Konstrictor **AD13720**
- 25" x 1" Schwalbe Right Run **AD13740**
- 25" x 1" Schwalbe Marathon Evo **AD13750**
- BMX Tread (std)

**26"**

- 26" x 1" HP Smooth (std)
- 26" x 1-3/8" Tread (std)
- 26" x 1" Solid (std)
- 26" x 1" Schwalbe Right Run **AD13740**
- 26" x 1" Schwalbe Marathon Evo **AD13750**
- BMX Tread (std)

**AXLES**

- Quick release axles (std)       Quad release **AD12500**

**PUSHRIMS**

- Anodised (std)       Anodised (1") **AD13855**       Foam **AD13840**       Natural Fit Lite **AD13860**
- Vinyl **AD13830**       Vinyl (1") **AD13859**       Surge **AD13864**       Max Greppe **AD13870**
- Rubber coated (black) **AD13850**       Rubber coated (1") **AD13857**       Surge Lite **AD13864**       Spinergy FlexRim - see Wheels

**PUSHRIMS - POSITION**

- Standard       In close       Onto rim

**SPOKE GUARDS**



















- Nil       Clear polycarb **AD13900**       Black ABS **AD13901**

# Panther Script Form

Fixed Frame Day Wheelchair

Name \_\_\_\_\_











**COLOURS**

- 27 Candy Blue 
- 1 Royal Blue 
- 72 Glass Blue 
- 16 Candy Purple 
- 48 Burgundy 
- 83 Candy Raspberry 
- 88 Fluro Pink 
- 28 Candy Red 
- 11 Flame 
- 57 Super Hot Chilli 
- 80 Candy Orange 
- 71 Pure Orange 
- 68 Crystal Yellow 
- 73 Crystal Jade 
- 89 Fluro Green 
- 70 Candy Emerald 
- 2 Hawthorn Green 
- 17 Crystal Sapphire 

**ATTENTION**

**THIS IS A GUIDE TO COLOURS ONLY, how colours appear on your monitor or when printed out may vary.**

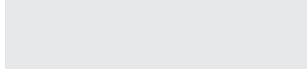
Contact us if you require assistance or a colour sample.  
 This colour selection is for our aluminum frames only.  
 We do not recommend powder coating titanium.  
 Colour availability is subject to change without notice, contact us if you are concerned about the availability of your colour.

- 55 Silver Sparkle 
- 12 Silver Orbiter 
- 46 Chrome 
- 42 Metallic Viper 
- 30 Satin Black 
- 61 High Gloss Black 
- 62 Matt Black 
- 63 Texture Matt Black 
- 18 Clear 
- Bead Blast** (titanium only) 
- Custom Colour** (additional cost)  
 Description \_\_\_\_\_