

Stallion Junior Script

Childrens Fixed Frame Day Wheelchair 90150



To Order Fill in the frame dimensions and features required. For variations describe in detail on a separate page. If you have any further questions contact us at the address at the bottom of the page.

SEND FORM
If online, click here to send via e-mail

| | | | | |
|------------------|-------------------------------|--------------|-----------------|--------------------|
| Date _____ | Delivery details _____ | | | |
| Name _____ | _____ | | | |
| Address _____ | _____ | | | |
| _____ | Therapist details _____ | | | |
| Phone _____ | _____ | | | |
| Fax / Cell _____ | Required by _____ | | | |
| Email _____ | TRIAL CHAIR REF: _____ | | | |
| Disability _____ | Weight _____ | Height _____ | Shoe Size _____ | T-Shirt Size _____ |

MEASUREMENTS (Refer to diagram below)

Growable Sizes Sizes up to 14" wide are growable up to 16" wide maximum

| | | | |
|----------------------------|---------------------------------------|-------------------------------------|---|
| A Seat width _____ | D Back angle (0° to 10°) _____ | G Seat to floor - rear _____ | J Camber (0° or 3°) _____ |
| B Seat depth _____ | E Seat to footplate _____ | H Balance Point _____ | K Front Style |
| C Back height _____ | F Seat to floor - front _____ | I Footplate width _____ | <input type="checkbox"/> Standard <input type="checkbox"/> Flared Front |

IMPORTANT Ensure measurements C, E, F, G provide allowance for the cushion thickness

ADDITIONAL NOTES

(you can type here)

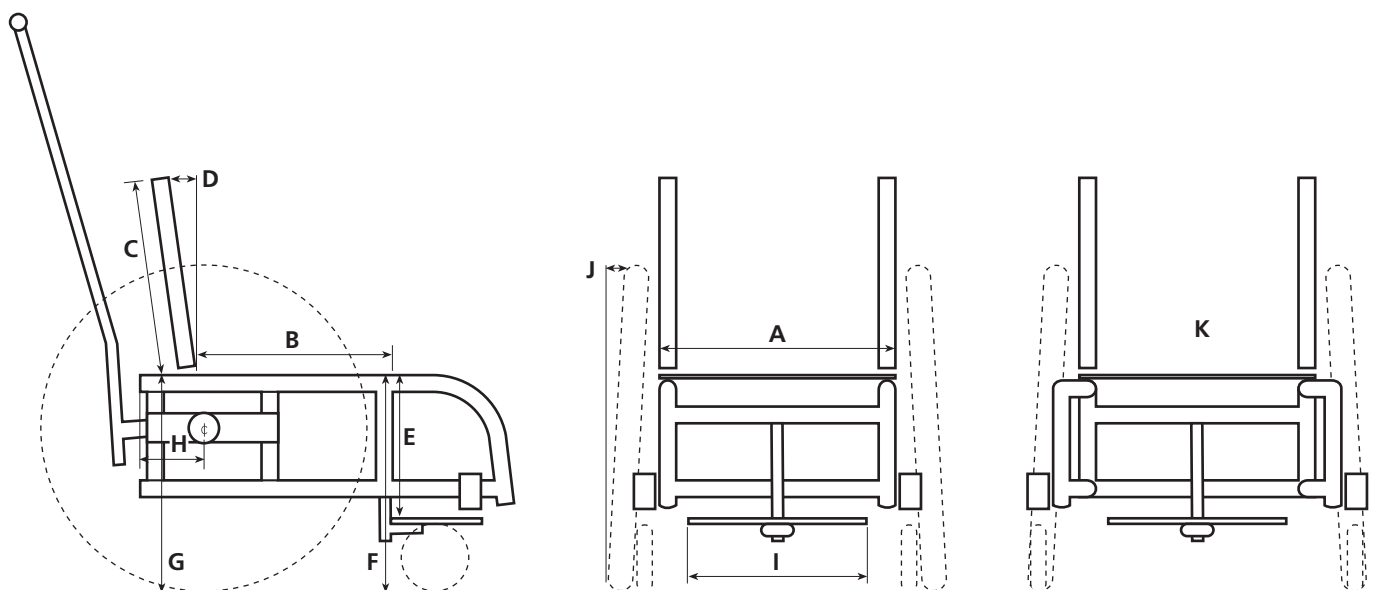

Revision 9 - Stallion Jr - June 2016

Stallion Junior Script

Childrens Fixed Frame Day Wheelchair

Name _____

WHEELS**TYRES****12.5"****12.5"** 12.5" Transit Wheels 12.5" Tread (std) 12.5" Solid Tread (std)**16"****16"** 16" x 1.75" Composite Wheels 16" x 1.75" Tread (std) 16" x 1.75" Solid Tread (std)**18"****18"** 18" x 1" Spoked Wheels 18" x 1" HP Smooth (std) 18" x 1.75" Composite Wheels 18" x 1.75" Grey Tread (std)**20"****20"** 20" Spoked Wheels 20" x 1" HP Smooth (std) 20" x 1.75" Spoked Wheels 20" x 1 3/8" Tread (std) 20" x 1 3/8" Composite Wheels 20" x 1 3/8" Solid Tread (std) 20" X-Core Composite Wheels 20" x 1.75" Grey Tread (std)**22"****22"** 22" Spoked Wheels 22" x 1" HP Smooth (std) 22" X-Core Composite Wheels 22" x 1 3/8" Tread (std) 22" Spinergy LX Wheels (12 spoke - black only) **AD13310** 22" x 1 3/8" Solid Tread (std) Spare Wheel(s) Type: _____

Tyres: _____ Pushrims: _____ Size: _____

AXLES Quick release axles (std) Quad release **AD12500****PUSHRIMS** Anodised (std) Rubber Coated (black) **AD13850** Capstan **AD13880** No. projections: _____ Angle: _____ Length: _____**PUSHRIMS - POSITION** Standard In close Onto rim**SPOKE GUARDS** Nil Clear polycarb **AD13900** Black ABS **AD13901** Custom design **AD13910**
Describe design below**ADDITIONAL NOTES**



















(you can type here)

Stallion Junior Script

Childrens Fixed Frame Day Wheelchair

Name _____

COLOURS

- 27 Candy Blue 
- 1 Royal Blue 
- 72 Glass Blue 
- 16 Candy Purple 
- 48 Burgundy 
- 83 Candy Raspberry 
- 88 Fluro Pink 
- 28 Candy Red 
- 11 Flame 
- 57 Super Hot Chilli 
- 80 Candy Orange 
- 71 Pure Orange 
- 68 Crystal Yellow 
- 73 Crystal Jade 
- 89 Fluro Green 
- 70 Candy Emerald 
- 2 Hawthorn Green 
- 17 Crystal Sapphire 

ATTENTION









THIS IS A GUIDE TO COLOURS ONLY, how colours appear on your monitor or when printed out may vary.

Contact us if you require assistance or a colour sample.

This colour selection is for our aluminum frames only.

We do not recommend powder coating titanium.

Colour availability is subject to change without notice, contact us if you are concerned about the availability of your colour.

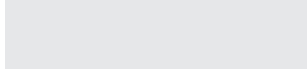
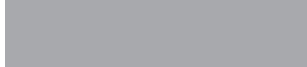
- 55 Silver Sparkle 
- 12 Silver Orbiter 
- 46 Chrome 
- 42 Metallic Viper 
- 30 Satin Black 
- 61 High Gloss Black 
- 62 Matt Black 
- 63 Texture Matt Black 
- 18 Clear 
- Bead Blast** (titanium only) 

Custom Colour (additional cost)

Description